

**Single Output Programmable
DC Power Supply
Operation Manual**

Contents

Safety Instruction.....	III
1. Product Introduction	1
1.1 Description	1
1.2 Features.....	1
2. Panel Introduction	2
2.1 Front and Rear Panel.....	2
2.2 Key Description.....	3
2.3 Indicators Description	4
3. Operation Introduction.....	4
3.1 Basic Operation	4
3.2 Input Mode	4
3.2.1 Numeric Keypad Input	4
3.2.2 Step Key Input	5
3.2.3 Knob Adjustment	5
3.2.4 Input Mode Selection	5
3.3 Parameters Setup.....	5
3.3.1 Output Voltage Setting	5
3.3.2 Output Current Setting	6
3.3.3 Over Voltage Protection Setting	6
3.3.4 Over Voltage Protection Status Setting	6
3.3.5 Over Current Protection Setting	7
3.3.6 Over Current Protection Status Setting	7
3.3.7 Voltage/Current Delay Time Setting	7
3.3.8 Output Voltage/Current Range Selection (only for the Models with Dual Range).....	7
3.4 Function Setup	8
3.4.1 Voltage Step Setting.....	8
3.4.2 Current Step Setting	8
3.4.3 RS232 Baud Rate Setting.....	8
3.4.4 Beeper Setting.....	9
3.4.5 Hotkey Setting	9
3.4.6 Voltage Self-test Setting	9
3.4.7 Software Version.....	9
3.4.8 Recall the Setting Data from the Memory Bank	9
3.4.9 Save the Setting Data to one of the Memory Groups.....	10
3.5 Auto Range.....	10
3.5.1 Start Memory Address Setting	10
3.5.2 End Memory Address Setting.....	11
3.5.3 Cycle Times Setting.....	11
3.6 Enter/Exit Auto Running Operation.....	11
3.7 Output.....	11
3.8 Lock	11
3.9 CV/CC Switch.....	12
3.10 Output Power Display.....	12
3.11 Rotary Knob.....	12
3.12 Over Temperature Protection.....	12

3.13 Operation Method	12
3.13.1 Constant Voltage Operation	12
3.13.2 Constant Current Operation	13
3.13.3 Store and Recall Operation	13
3.13.4 Auto Running Operation	13
4. Remote Control.....	14
4.1 Interface Setting	14
4.1.1 Interface.....	14
4.1.2 COM Port Setting.....	14
4.2 SCPI Commands	15
5. Maintenance	15
5.1 Inspection	15
5.2 Fuse Replacement.....	15
6. Technical Specifications	16
6.1 Data Sheet	16
6.2 Maximum Setting Value	19

Use of Operation Manual

Please read through and understand this Operation Manual before operating the product. After reading, always keep the manual nearby so that you may refer to it as needed. When moving the product to another location, be sure to bring the manual as well.

Calibration notification

We notify that the instruments included in this manual are in compliance with the features and specifications as stated in this manual. Before shipment, the instrument has been calibrated in factory. The calibration procedures and standards are compliant to the national regulations and standards for electronic calibration.

Warranty

We guarantee that the instrument has been passed strict quality check. We warrant our instrument's mainframe and accessories in materials within the warranty period of one year. We guarantee the free spare parts for products which are approved defective in this period. To get repair service, please contact with your nearest sales and service office. We do not provide any other warranty items except the one being provided by this summary and the warranty statement. The warranty items include but not being subjected to the hinted guarantee items related to tradable characteristics and any particular purpose. We will not take any responsibility in cases regarding to indirect, particular and ensuing damage, such as modifications to the circuit and functions by the users, repairing or component replacement by the users, or damage during transportation.

For product improvement, the specifications are subject to change without prior notice.

Safety Instruction

This chapter contains important safety instructions that you must follow when operating the instrument and when keeping it in storage. Read the following before any operation to insure your safety and to keep the best condition for the instrument.

Safety Symbols

The following safety symbols may appear in this manual or on the instrument:



WARNING

Identifies conditions or practices that could result in injury or loss of life.



CAUTION

Identifies conditions or practices that could result in damage to the instrument or to other properties.



DANGER

High voltage



ATTENTION

Refer to the manual



Protective conductor terminal



Earth (ground) terminal

Safety Guidelines



CAUTION

- Before plugging into local AC mains, check and make sure that the output voltage is compatible to the load. (It is suggested to disconnect a load before plugging into local AC mains.)
 - Do not use this instrument near water.
 - Do not operate or touch this instrument with wet hands.
 - Do not open the casing of the instrument when it is connected to AC mains.
 - The max.output voltage of the instrument may be over 60VDC, avoid touch the metal contact part of the output terminals.
 - Do not use the instrument in an atmosphere which contains sulfuric acid mist or other substances which cause corrosion to metal.
 - Do not use the instrument in a dusty place or a highly humid place as such will cause instrument reliability degradation and instrument failures.
 - Install the instrument in a place where is free from vibration.
 - Install the instrument in a place where the ambient temperature is in range of -10~70°C. Note that the instrument operation may become unstable if it is operated in an ambient temperature exceeding the range of 0~40°C
-

Power supply

AC Input voltage: 110V/220V \pm 10%, 50/60Hz



WARNING

Connect the protective grounding conductor of the AC power cord to an earth ground to avoid electrical shock.

Fuse



WARNING

- Fuse type: **please refer to section 5.2 for details.**
 - Make sure the correct type of fuse is installed before power up.
 - Replace the AC fuse with the same type and rating as the original fuse.
 - Disconnect the power cord before fuse replacement.
 - Make sure the cause of fuse blowout is fixed before fuse replacement.
-

Cleaning

- Disconnect the power cord before cleaning.
 - Use a soft cloth dampened in a solution of mild detergent and water. Do not spray any liquid.
 - Do not use chemicals or cleaner containing harsh material such as benzene, toluene, xylene, and acetone.
-

Operation environment

- Location: indoor, no direc sunlight, dust free, almost non-conductive pollution (note below).
- Relative humidity: <80%
- Altitude: <2000m
- Temperature: 0°C ~ 40°C

(Pollution Degree) EN 61010-1:2001 specifies the pollution degrees and their requirements as follows. The instrument falls under degree 2.

Pollution refers to “addition of foreign matter, solid, liquid, or gaseous (ionized gases), that may produce a reduction of dielectric strength or surface resistivity”.

Pollution degree 1: No pollution or only dry, non-conductive pollution occurs. The pollution has no influence.

Pollution degree 2: Normally only non-conductive pollution occurs. Occasionally, however, a temporary conductivity caused by condensation must be expected.

Pollution degree 3: Conductive pollution occurs, or dry, nonconductive pollution occurs

which becomes conductive due to condensation which is expected. In such conditions, equipment is normally protected against exposure to direct sunlight, precipitation, and full wind pressure, but neither temperature nor humidity is controlled.

Storage environment	● Location: indoor
	● Relative humidity: <70%
	● Temperature: -10°C ~ 70°C

Power cord for the United Kingdom

When using the power supply series in the United Kingdom, make sure the power cord meets the following safety instructions.

NOTE: This lead/appliance must only be wired by competent persons.



WARNING: THIS APPLIANCE MUST BE EARTHED.

IMPORTANT: The wires in this lead are coloured in accordance with the following code:

Green/Yellow:	Earth
Blue:	Neutral
Brown:	Live



As the colours of the wires in main leads may not correspond with the colours marking identified in your plug/appliance, proceed as follows:

- The wire which is coloured Green & Yellow must be connected to the Earth terminal marked with the letter E or by the earth symbol \oplus or coloured Green or Green & Yellow.
- The wire which is coloured Blue must be connected to the terminal marked with the letter N or coloured Blue or Black.
- The wire which is coloured Brown must be connected to the terminal marked with the letter L or P or coloured Brown or Red.

If in doubt, consult the instructions provided with the equipment or contact the supplier.

This cable/appliance should be protected by a suitably rated and approved HBC mains fuse: refer to the rating information on the equipment and/or user instructions for details. As a guide, cable of 0.75mm² should be protected by a 3A or 5A fuse. Larger conductors would normally require 13A types, depending on the connection method used.

Any moulded mains connector that requires removal/replacement must be destroyed by removal of any fuse & fuse carrier and disposed of immediately, as a plug with bared wires is hazardous if engaged in live socket. Any re-wiring must be carried out in accordance with information detailed on this label.

1. Product Introduction

1.1 Description

This series of Single Output Programmable Power Supply is controlled by Micro Processor Unit (MPU) with extreme high accuracy, which can easily connect communication interface RS-232 or USB to computer in order to satisfy users' demand for auto-testing and auto-control. The software commands are fully complied with the SCPI format, it is convenient for user to proceed auto-tested and auto-controlled application program. Also, the digitalization of system makes a speedy, precise and convenient input of information controlled by keyboard. The adjustment of voltage/current is made by software calibration without manual error that will increase the preciseness of the instrument.

1.2 Features

- Single output with dual range (only for the models with dual range)
- High resolution 1mV/0.1mA
- 24 bits ADC and 16 bits DAC, high accuracy
- Safety design: OLP, OVP, OCP, OTP and reverse polarity protection
- Auto CC and CV switch
- 122×32 LCD display
- Convenient and high efficiency operation of setting interface, high speed rotary knob and numeric key input
- Warning buzzer
- Key-lock to prevent improper operation
- Output ON/OFF control
- Save and Recall function of 100 groups setting and proceed together with auto operation can achieve the purpose of auto test
- Standard interface: USB or RS232
- Support SCPI commands

2. Panel Introduction

2.1 Front and Rear Panel

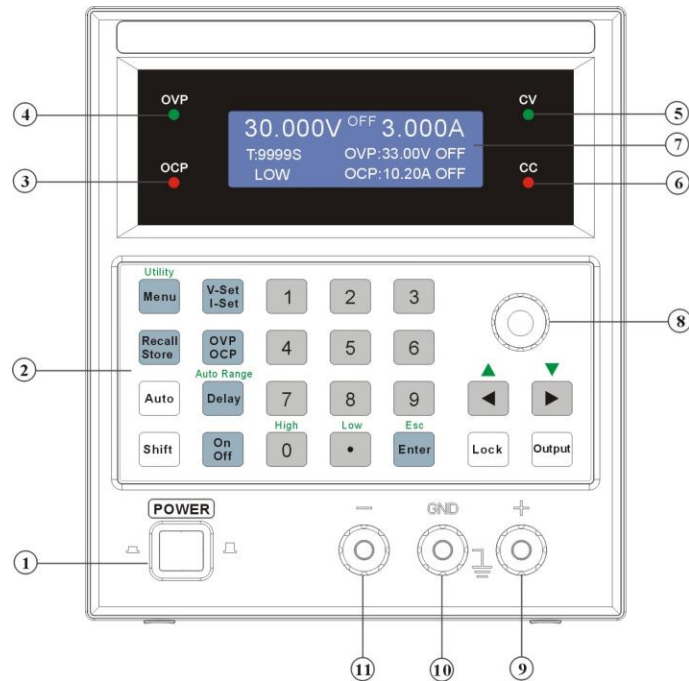

Fig.2.1-1 Front Panel

- | | | |
|------------------|------------------------------------|------------------------------|
| 1. Power switch | 2. Function key and Numeric keypad | 3. OCP indicator |
| 4. OVP indicator | 5. CV indicator | 6. CC indicator |
| 8. Rotary knob | 9. Positive output terminal | 10. Ground terminal |
| | | 11. Negative output terminal |

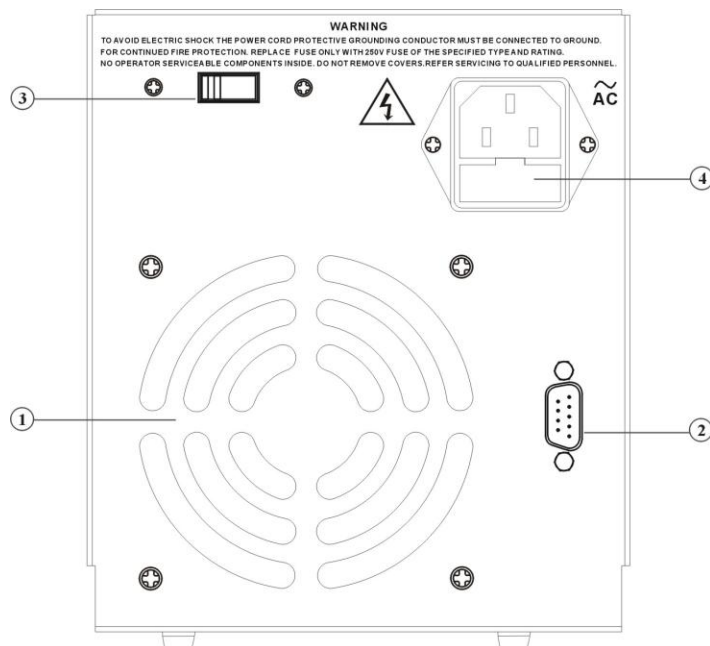

Fig.2.1-2 Rear Panel

- | | |
|--------------------------------------|-----------------------------|
| 1. Cooling fan | 2. RS232 or USB interface |
| 3. AC110/220V power selection switch | 4. Power cord / fuse socket |

2.2 Key Description

There are 24 keys on the front panel. The word on each key represents the basic function. Directly press the key to use the basic function. The word at the upper of key represents the second function of the key. Press key **[Shift]**, and the shift key light turns on. Then press the function key, you can select the second function.

In this section, the basic functions of the 24 keys will be introduced. The second functions of the 7 keys will be introduced in the following chapters.

Numeric keys

Key name	Main function	Second function
0	Input digit 0	High range selection (only for the models with dual range)
1	Input digit 1	Not available
2	Input digit 2	Not available
3	Input digit 3	Not available
4	Input digit 4	Not available
5	Input digit 5	Not available
6	Input digit 6	Not available
7	Input digit 7	Not available
8	Input digit 8	Not available
9	Input digit 9	Not available
●	Input decimal point	Low range selection (only for the models with dual range)
◀	Flash digit left shift	Add digit
▶	Flash digit right shift	Subtract digit

Function keys

Key name	Main function	Second function
Menu	Menu selection	Function setup
V-Set/I-Set	Voltage/current setup	Not available
Delay	Set the voltage and current output time in the automatic operation mode	Auto range setup
Auto	Turn on/off the auto operation	Not available
Recall/Store	Recall/store parameters	Not available
OVP/OCP	OVP/OCP setup	Not available
On/Off	Turn on/off a function	Not available
Enter	Confirm the input	Exit the input
Lock	Lock up panel setting	Not available
Output	Turn on/off the output	Not available
Shift	Shift to 2'nd function with other keys	Not available

Key functions: 24 keys are available on front panel and a “di” sound will be heard when pressed.

Key **[Menu]**: press key **[Menu]** without numeric input, users can select all options under the current function.

A few keys have second functions that are marked in green above the keys. To use the second function, key **[Shift]** should be pressed first before pressing the function key.

Key **[Shift]**: its basic function is for second function shifting. Press key **[Shift]**, the key light turns on. At this time, the second function of the function key is validated. Press key **[Shift]** again, the key light turns off. At this time, the basic function of the function key is validated.

2.3 Indicators Description



There are four indicators on both sides of the screen, as shown above.

CV indicator: The CV light turns green to indicate the instrument is in the CV mode.

CC indicator: The CC light turns red to indicate the instrument is in the CC mode.

OVP indicator: The OVP light turns green to indicate the over voltage protection function is on.

OCP indicator: The OCP light turns red to indicate the over current protection function is on.

3. Operation Introduction

3.1 Basic Operation

- (1) The applied Voltage/Current Unit for this series instruments is Volt and Amp.
- (2) The factory setting is in panel operation mode that enable user to operate the instruments directly from panel control knob. Besides, when the remote controller is on line, the Lock key light turns on and the operation can only be proceed through it. At this time, all the panel operations are closed unless the key **[Lock]** is pressed, but the Output is still working. Whenever the power is reset, the output will be at OFF status and the operation is through front panel operation mode.
- (3) The output of power supplies is always at OFF status after power on.
- (4) When users operate the power supply with dual range, during the switch process, the output is at OFF automatically. And if the original setting value is more than the maximum output range after switch, the setting value will be modified automatically to the maximum output value after switch.
- (5) When the Output key light turns on, the CV or CC indicator at the right side of the LCD represents the instrument is in the CV or CC mode and the LCD displays the output measurement value.

3.2 Input Mode

3.2.1 Numeric Keypad Input

If an option is selected, you can input the parameters by using the numeric keys. There are ten numeric keys for data input. The input method is the shift input from right to left. The data can have only one decimal point. If one data input has more than one decimal point, only the first one is valid. After input a new value, press key **[Enter]** to validate it. If the input data has error, there are three ways to correct it.

Method 1: If the destination side of output signal can receive the wrong signal, press key **[Enter]** to terminate the current operation. Input the correct data, and press the key **[Enter]** to validate the input.

Method 2: If the destination side of output signal can not receive the wrong signal, the wrong input is not validated because of no any wrong signal at the output. Reselect the operation, input correct data, and press the key **[Enter]** to validate the input.

Method 3: Press keys **[Shift] [Enter]**, then input the correct data, and press the key **[Enter]** to validate the input.

3.2.2 Step Key Input

In practices, a set of voltage or current value with same interval is commonly used. It is complicated and time consuming to input this kind of data by repeatedly pressing the numeric keypad and Enter key. It is also complex by using the rotary knob because voltage or current value may be multi-digit. It is very convenient to use the step input method. Every pressing the corresponding soft key can make the voltage or current increase or decrease by a step value. The modified data is validated automatically without pressing the Enter key.

For example, to generate a series of voltage with interval 1.1V, press the keys sequentially as following:

Press keys **[Shift] [Menu]** to enter function setting interface,

Press key **[Menu]** again until “Utility V Step” is shown on the LCD,

Press keys **[1] [.] [1] [Enter]** to complete step voltage value setup,

Press key **[V-Set/I-Set]** again until “Voltage” is shown on the LCD,

Press keys **[Shift] [◀]** to increase the voltage by 1.1V or press keys **[Shift] [▶]** to decrease the voltage by 1.1V. Repeat this operation, a series of voltage with equal interval can be generated. The same procedure can be used for the current operation.

3.2.3 Knob Adjustment

In some applications, it requires to adjust the output signal continuously. Using the rotary knob can complete this task. Press key **[◀]** or **[▶]** to move the cursor left or right. Rotate the knob to the right to continuously increase the cursor-located digit by 1 and make the carry to a higher unit position. Rotate the knob to the left to continuously decrease the cursor-located digit by 1 and make the carry to a lower unit position. When you use the knob to modify a specified data, the modified data is validated instantaneously without pressing the Enter key. A coarse adjustment is made by moving the cursor to the left; and a fine adjustment is made by moving the cursor to the right.

3.2.4 Input Mode Selection

It is convenient to input the known data through the numeric keypad. It makes the input be set at only one step without the intermediate transition data. For the partial modification of the input data or at the situation of monitoring the variation process of the input data, the rotary knob is usually more useful. For a series of equal interval data input, the step input method is the most efficient. Users can use the different data input methods according to different situations.

3.3 Parameters Setup

Press key **[Menu]** to select and set the parameters in this section.

3.3.1 Output Voltage Setting

Press key **[V-Set/I-Set]** until “Voltage” is shown on the LCD.

Setting method 1: Press **[Number key (voltage value)] [Enter]** to set output voltage.

Setting method 2: Press **[Number knob (voltage value)]** to change the output voltage setting immediately. When use this method with the output ON, the output voltage will be changed following the input value by rotating the knob. Press key **[◀]** or **[▶]** to move the cursor left or right, and tune the rotary knob left or right to add or subtract the digit on cursor, or to decrease or increase the digits continuously by steps, so as to make coarse or fine adjustment of the voltage. Apply the same procedures for other parameters adjustments.

For example: Set output voltage to 32.000V.

Press [V-Set] [3] [2] [.] [0] [0] [0] [Enter].

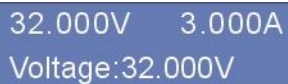

32.000V 3.000A
Voltage:32.000V

3.3.2 Output Current Setting

Press key [V-Set/I-Set] until “Current” is shown on the LCD.

Setting method 1: Press [Number key (current value)] [Enter] to set output current.

Setting method 2: Press [Number knob (current value)] to change the output current setting immediately. When use this method with the output ON, the output current will be changed following the input value by rotating the knob.

For example: Set output current to 3.200A.

Press [I-Set] [3] [.] [2] [0] [0] [Enter].



30.000V 3.200A
Current:3.200A

3.3.3 Over Voltage Protection Setting

Press key [OVP], to set the maximum output voltage. If the adjusted value or actual output value is more than the maximum value, the output voltage will automatically stop, the OVP indicator turns on, and warning signal by the beeper will be heard.

Press key [OVP/OCP] until “OVP Set” is shown on the LCD.

Setting method 1: Press [Number key (voltage value)] [Enter] to complete OVP setting.

Setting method 2: Press [Number knob (voltage value)] to change OVP setting immediately.

For example: Set over voltage protection value to 33.0V.

Press [OVP] [3] [3] [.] [0] [Enter].



30.000V 3.000A
OVP Set:33.0V

3.3.4 Over Voltage Protection Status Setting

Press key [Menu] until “OVP Status” is shown on the LCD, to proceed over voltage protection status setting, then press [On/Off] to turn on or off the OVP function.



30.000V 3.000A
OVP Status:ON

3.3.5 Over Current Protection Setting

Press key [**OCP**], to set the maximum output current. If the adjusted value or actual output value is more than the maximum value, the output current will automatically stop, the OCP indicator turns on, and warning signal by the beeper will be heard.

Press key [**OVP/OCP**] until “OCP Set” is shown on the LCD.

Setting method 1: Press [**Number key (current value)**] [**Enter**] to complete OCP setting.

Setting method 2: Press [**Number knob (current value)**] to change OCP setting immediately.

For example: Set over current protection value to 3.30A.

Press [**OCP**] [**3**] [**.**] [**3**] [**0**] [**Enter**].



30.000V 3.000A
OCP Set:3.30A

3.3.6 Over Current Protection Status Setting

Press key [**Menu**] until “OCP Status” is shown on the LCD, to proceed over current protection status setting, then press [**On/Off**] to turn on or off the OCP function.



30.000V 3.000A
OCP Status:ON

3.3.7 Voltage/Current Delay Time Setting

Press key [**Delay**], “Delay” is shown on the LCD.

Setting method 1: Press [**Number key (delay time)**] [**Enter**] to complete voltage and current delay time setting.

Setting method 2: Press [**Number knob (delay time)**] to change voltage and current delay time setting immediately.

For example: Set the delay time to 99999s.

Press [**Delay**] [**9**] [**9**] [**9**] [**9**] [**9**] [**Enter**].



30.000V 3.000A
Delay :99999s

Note: The Delay setting is effective only under the Auto running operation, therefore, during the storage proceeding, the Delay setting will be saved to the memory address simultaneously.

3.3.8 Output Voltage/Current Range Selection (only for the Models with Dual Range)

Press [**Shift**][**0**], the message of “Range: High” shown on the LCD represents the high range is selected.

Press [**Shift**][**.**], the message of “Range: Low” shown on the LCD represents the low range is selected.

This function is effective only under the parameter setting.

For example: The output range of the power supply is at high range.

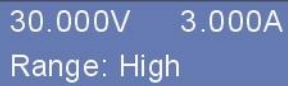

30.000V 3.000A
Range: High

Note:

- If the output is at ON, it will shut down automatically during the switch process.
- When the setting value is more than the value of the switched voltage/current range, it will be modified to maximum value of the switched range automatically. If the setting value is less than the value of the switched voltage/current range, it will be stayed as it is.

3.4 Function Setup

Press [**Shift**] [**Menu**], proceed to the function setting, then press [**Menu**] to select the options under the current function.

3.4.1 Voltage Step Setting

Set the maximum value of Step to be the rating value of the setting range.

Press key [**Menu**] until “Utility V Step” is shown on the LCD.

Setting method 1: Press [**Number key (voltage value)**] [**Enter**] to set step voltage.

Setting method 2: Press [**Number knob (voltage value)**] to change step voltage immediately.

For example: Set the step voltage to 10.000V.

Press [**1**] [**0**] [**.**] [**0**] [**0**] [**0**] [**Enter**].

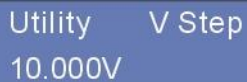

Utility V Step
10.000V

3.4.2 Current Step Setting

Set the maximum value of Step to be the rating value of the setting range.

Press key [**Menu**] until “Utility I Step” is shown on the LCD.

Setting method 1: Press [**Number key (current value)**] [**Enter**] to set step current.

Setting method 2: Press [**Number knob (current value)**] to change step current immediately.

For example: Set the step current to 0.500A.

Press [**0**] [**.**] [**5**] [**0**] [**0**] [**Enter**].



Utility I Step
0.500A

3.4.3 RS232 Baud Rate Setting

Press key [**Menu**] until “Utility Baud” is shown on the LCD, use the numeric keypad or knob to modify the corresponding code of baud rate to make sure that the baud rate meets the requirement of the PC remote control.

The table below shows the corresponding code of baud rate.

Code	0	1	2	3	4	5	6	7	8	9
Baud rate	1200	2400	4800	9600	14400	19200	28800	38400	57600	115200

Setting method 1: Press [**Number key (code)**] [**Enter**] to set baud rate.

Setting method 2: Press [**Number knob (code)**] to change baud rate immediately.

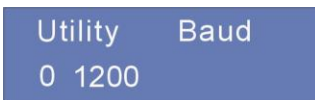

3.4.4 Beeper Setting

Press key [**Menu**] until “Utility Beep” is shown on the LCD, then press [**On/Off**] to turn on or off the beeper.



3.4.5 Hotkey Setting

Press key [**Menu**] until “Utility HotKey” is shown on the LCD, then press [**On/Off**] to turn on or off the hotkey function. The original status is at OFF, press [**On/Off**] once, the status is changed to ON. After leaving the Menu, the number 0 to 9 means the setting data of index number 0 to 9 in memory bank. So the setting data of index number 0 to 9 can be recalled by pressing the corresponding number.



3.4.6 Voltage Self-test Setting

Press key [**Menu**] until “Utility VselfTe” is shown on the LCD, then press [**On/Off**] to turn on or off the voltage self-test function. The original status is at ON, press [**On/Off**] once, the status is changed to OFF. Users can enable this function to improve the voltage accuracy and get the accurate setting voltage at the output terminal.



3.4.7 Software Version

Press key [**Menu**] until “Version” is shown on the LCD, at this time the instrument software version is displayed.



3.4.8 Recall the Setting Data from the Memory Bank

Press key [**Menu**] or [**Recall/Store**] until “Utility Recall” is shown on the LCD, use the number key to input the

memory address to recall the data, then press **[Enter]** to complete the recall.

For example: Recall the setting data from the memory address of 5.

Press **[5] [Enter]**.



Note: When a setting is recalled, the output automatically turns off.

3.4.9 Save the Setting Data to one of the Memory Groups

Press key **[Menu]** or **[Recall/Store]** until “Utility Store” is shown on the LCD, use the number key to input the memory address to save the data, then press **[Enter]** to complete the store.

For example: Store the setting data to the memory address of 5.

Press **[5] [Enter]**.



Note: The storing setting function includes the store of the Output range, Output voltage value, Output current value, Over Voltage Protection level, Over Current Protection level, Over Voltage Protection status, Over Current Protection status and the Delay time.

3.5 Auto Range

Press key **[Shift [Delay]]** until “Auto Start” is shown on the LCD, enter auto range setting item selection, press **[Menu]** to select the options under the current function.

When users operate the power supply with dual range, the several groups of running stored parameters should be set under the same ranges, otherwise, during the auto running and switch process, the output is at OFF automatically.

3.5.1 Start Memory Address Setting

Press key **[Menu]** until “Auto Start” is shown on the LCD.

Setting method 1: Press **[Number key (memory address)] [Enter]** to set start memory address.

Setting method 2: Press **[Number knob (memory address)]** to change start memory address immediately.

For example: Set the start memory address to 0.

Press **[0] [Enter]**.



3.5.2 End Memory Address Setting

Press key [Menu] until “Auto End” is shown on the LCD.

Setting method 1: Press [Number key (memory address)] [Enter] to set end memory address.

Setting method 2: Press [Number knob (memory address)] to change end memory address immediately.

For example: Set the end memory address to 8.

Press [8] [Enter].



3.5.3 Cycle Times Setting

Press key [Menu] until “Auto Cycle” is shown on the LCD.

Setting method 1: Press [Number key (cycle times)] [Enter] to set cycle times from number 0 to 99999. Number 0 represents infinite loop.

Setting method 2: Press [Number knob (cycle times)] to change cycle times immediately.

For example: Set the cycle times to 99.

Press [9] [9] [Enter].



3.6 Enter/Exit Auto Running Operation

Press [Auto] to enter or exit the auto running operation mode. If the Auto key light turns on, it means the instrument has entered the auto running operation.

Under this mode, LeftTime shown on the LCD represents the left time, LeftCycle represents left executed cycles, No. means the memory address, High/Low is high or low range. (The message High/Low is only for the models with dual range.)



3.7 Output

The Output key is for turning on or off the output.

3.8 Lock

The Lock key is for locking up the panel setting. When the key light turns on, the other key and knob is disabled except Lock and Output key.

3.9 CV/CC Switch

When the output current level reaches the setting with the Output ON, the CC indicator turns red, the instrument operates in Constant Current mode. When the output voltage level reaches the setting, the CV indicator turns green, the instrument operates in Constant Voltage mode. The instrument automatically switches between Constant Current mode and Constant Voltage mode, according to load condition.

3.10 Output Power Display

When the Output is at ON, the LCD displays the current output power.

3.11 Rotary Knob

Press Knob to quickly return to the last setting operation.

3.12 Over Temperature Protection

The instrument provides the Over Temperature Protection function. In order to insure user's safety and safe operation for instrument, the output will automatically turns off if the instrument produces abnormal high temperature during operation process.

3.13 Operation Method

The applied Voltage/Current Unit for this series instruments is Volt and Amp.

3.13.1 Constant Voltage Operation

- (1) Connect load to output terminal.
For the safety, when connect the load to output terminals of (+) and (-), it must turn off the power.
- (2) Select output range.
Turn on the power after the load is well connected, select the adequate operation range by pressing [**High**] or [**Low**].
- (3) Set the current limit value.
Press [**V-Set/I-Set**] until "Current" is shown on the LCD, the panel operation is set to current value input mode, set the desired change value by using the number key or the knob (the knob can be used together with [**◀**] or [**▶**] to adjust the resolution).
- (4) Set the desired output voltage value.
Press [**V-Set/I-Set**] until "Voltage" is shown on the LCD, the panel operation is set to voltage value input mode, set the desired change value by using the number key or the knob (the knob can be used together with [**◀**] or [**▶**] to adjust the resolution).
- (5) Start the output.
Press [**Output**] to enable output, now, the meter displays the actual output measurement value.
- (6) Constant voltage mode confirmation.
Check whether the CV indicator is on or not to make sure the output operation is under the constant voltage

mode. If the CC indicator is on, it needs to enlarge its current limit value to assure that the output operation is under constant voltage mode.

3.13.2 Constant Current Operation

- (1) Connect load to output terminal.

For the safety, when connect the load to output terminals of (+) and (-), it must turn off the power.

- (2) Select output range.

Turn on the power after the load is well connected, select the adequate operation range by pressing **[High]** or **[Low]**.

- (3) Set the voltage limit value.

Press **[V-Set/I-Set]** until “Voltage” is shown on the LCD, the panel operation is set to voltage value input mode, set the desired change value by using the number key or the knob (the knob can be used together with **[◀]** or **[▶]** to adjust the resolution).

- (4) Set the desired output current value.

Press **[V-Set/I-Set]** until “Current” is shown on the LCD, the panel operation is set to current value input mode, set the desired change value by using the number key or the knob (the knob can be used together with **[◀]** or **[▶]** to adjust the resolution).

- (5) Start the output.

Press **[Output]** to enable output, now, the meter displays the actual output measurement value.

- (6) Constant current mode confirmation.

Check whether the CC indicator is on or not to make sure the output operation is under the constant current mode. If the CV indicator is on, it needs to enlarge its voltage limit value to assure that the output operation is under constant current mode.

3.13.3 Store and Recall Operation

The storing setting function includes the store of the Output range, Output voltage value, Output current value, Over Voltage Protection level, Over Current Protection level, Over Voltage Protection status, Over Current Protection status and the Delay time.

- (1) Store the present setting status to the memory bank.

Press **[Recall/Store]** until “Utility Store” is shown on the LCD, set the panel operation to storing setting selection, input the desired memory address by using number key or knob, then press **[Enter]** to complete the change of store.

- (2) Recall the setting status from the memory bank.

Press **[Recall/Store]** until “Utility Recall” is shown on the LCD, set the panel operation to recall setting selection, use the number key or knob to recall the desired memory address, then press **[Enter]** to complete the change of recall.

3.13.4 Auto Running Operation

The function must be used together with the Delay setting which is defined as the operation delay time of next running operation. The Delay function is workable only under Auto Running operation.

- (1) The setting and store of very group of data.

A group setting includes the Output range, Output voltage value, Output current value, Over Voltage

Protection level, Over Current Protection level, Over Voltage status (ON/OFF), Over Current status (ON/OFF), and Delay time. User can proceed the setting and store it to the memory bank group by group up to 100 groups maximum.

- (2) Recall range setting (Auto running operation range).
Regarding the setting description, please refer to Auto Range operation in section 3.5.
- (3) Enter Auto mode by pressing [**Auto**], now, the operation is in the auto running function.
- (4) Press [**Output**] to turn on the output.
- (5) Under this mode, it can monitor the current operation setting address, left time and left cycle.

4. Remote Control

With the remote control function provided, this series power supply can communicate with PC by RS232 or USB interface and enable all the panel operations by series port software.

4.1 Interface Setting

4.1.1 Interface

The RS232 or USB interface is installed on the real panel of instrument.



RS232 interface



USB interface

4.1.2 COM Port Setting

Set up the COM port inside PC according to the following list

- (1) Baud rate: 9600
- (2) Parity bit: None
- (3) Data bit: 8
- (4) Stop bit: 1
- (5) Data flow control: None

Note 1: If there is no response under the remote control, please inspect the following items.

- Check whether the interface cable is connected or not.
- Check whether the pin connection among interface cable, power cord and PC is correct or not.
- Check whether the interface cable is tight or not.
- Check whether the communication parameters setup is corresponding to COM port setting or not.
- Check whether the end character is line break (hexadecimal 0X0A) or not.

Note 2: When the remote controller is on line, the Lock key light turns on and the operation can only be proceed through it. At this time, all the panel operations are closed unless the key [**Lock**] is pressed.

4.2 SCPI Commands

For detailed SCPI commands, please refer to the programming software in the CD ROM attached to the instrument.

5. Maintenance

5.1 Inspection

- Inspect the instrument at regular intervals so that it maintains its initial performance for a long time.
- Check the input power cord for damage of the vinyl cover and overheating of the plug and cord stopper. Check the terminal screws and binding posts for loosening.

5.2 Fuse Replacement

Step (1) Take off the power cord and remove the fuse socket using a minus driver.

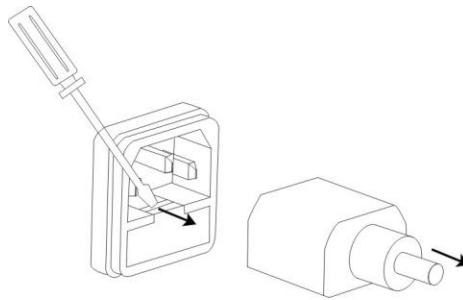

(2) Replace the fuse in the holder.

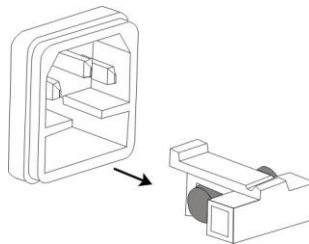

Fuse rating (1) 110V/115V: T6.3A/250V
220V/230V: T3.15A/250V (only for Model A, B, C, D, E, F, H, J)

(2) 110V/115V: T10A/250V
220V/230V: T5A/250V (only for Model G, I, K)

6. Technical Specifications

6.1 Data Sheet

The specifications apply when the power supply series are powered on for at least 30 minutes under regulated temperature.

Table 6.1-1

Model	Model A		Model B		Model C	Model D	Model E	Model F
Output range	36V/3A	15V/6A	36V/5A	15V/10A	30V/3A	30V/5A	60V/1A	60V/3A
Rating DC output (0°C ~40°C)								
Voltage	0~36V	0~15V	0~36V	0~15V	0~30V	0~30V	0~60V	0~60V
Current	0~3A	0~6A	0~5A	0~10A	0~3A	0~5A	0~1A	0~3A
OVP	0.1~38V				0.1~34V	0.1~34V	0.1~64V	0.1~64V
OCP	0.1~6.5A		0.1~11A		0~3.5A	0~5.5A	0~1.5A	0~3.5A
Voltage output								
Line regulation	≤0.01%+3mV							
Load regulation	≤0.01%+3mV (I≤3A) / ≤0.02%+5mV (I>3A)							
Recovery time	≤100us (50% load change, minimum load 0.5A)							
Ripple & Noise	≤1mV rms (I≤3A) (5Hz~1MHz) / ≤2mV rms (I>3A) (5Hz~1MHz)							
Temp. co-efficient	≤300ppm/°C							
Setting accuracy	±(0.03% of reading + 10mV) (25±5°C)							
Setting resolution	1mV							
Current output								
Line regulation	≤0.2%+3mA							
Load regulation	≤0.2%+3mA (I≤3A) / ≤0.2%+5mA (I>3A)							
Ripple & Noise	≤3mA rms (I≤3A) / ≤6mA rms (I>3A)							
Setting accuracy	±(0.2% of reading + 10mA) (25±5°C)							
Setting resolution	0.1mA		1mA		0.1mA	0.1mA	0.1mA	0.1mA
Display								
Voltage	5 digits display							
Current	5 digits display							
Voltage resolution	1mV							
Current resolution	0.1mA		1mA		0.1mA	0.1mA	0.1mA	0.1mA

Readback accuracy (25±5°C)	±(0.02% of reading +5mV) ±(0.02% of reading +5mA)					
Protection	OLP, OVP, OCP, OTP and reverse polarity protection					
Key lock	Provided					
Interface	RS232 or USB interface, SCPI commands provided					
Save /Recall	100 sets					
Insulation	Between chassis and output terminal: ≥20MΩ/500VDC Between chassis and AC cord: ≥30MΩ/500VDC					
Operation environment	Indoor use Altitude: ≤2000m Ambient temperature: 0~40°C Relative humidity: ≤80% Installation category: II Pollution degree: 2					
Storage environment	Ambient temperature: -10~70°C Relative humidity: ≤70%					
Power source	AC 110V/220V±10%, 50/60Hz					
Accessories	Operation manual, Power cord, Software CD, RS232 cable or USB cable					
Dimension	296 (D) ×126 (W) ×143 (H)mm					
Weight	≤5.5kg	≤6.2kg	≤5.5kg	≤5.5kg	≤5.5kg	≤5.5kg

Table 6.1-2

Model	Model G	Model H	Model I	Model J	Model K
Output range	60V/5A	20V/10A	30V/10A	75V/3A	75V/5A
Rating DC output (0°C ~40°C)					
Voltage	0~60V	0~20V	0~30V	0~75V	0~75V
Current	0~5A	0~10A	0~10A	0~3A	0~5A
OVP	0.1~64V	0.1~24V	0.1~34V	0.1~80V	0.1~80V
OCP	0~5.5A	0.1~11A	0.1~11A	0~3.5A	0~5.5A
Voltage output					
Line regulation	≤0.01%+3mV				
Load regulation	≤0.01%+3mV (I≤3A) / ≤0.02%+5mV (I>3A)				
Recovery time	≤100us (50% load change, minimum load 0.5A)				
Ripple & Noise	≤1mV rms (I≤3A) (5Hz~1MHz) / ≤2mV rms (I>3A) (5Hz~1MHz)				
Temp. co-efficient	≤300ppm/°C				
Setting accuracy	±(0.03% of reading + 10mV) (25±5°C)				
Setting resolution	1mV	1mV	1mV	2mV	2mV
Current output					

Line regulation	$\leq 0.2\% + 3\text{mA}$					
Load regulation	$\leq 0.2\% + 3\text{mA}$ ($I \leq 3\text{A}$) / $\leq 0.2\% + 5\text{mA}$ ($I > 3\text{A}$)					
Ripple & Noise	$\leq 3\text{mA rms}$ ($I \leq 3\text{A}$) / $\leq 6\text{mA rms}$ ($I > 3\text{A}$)					
Setting accuracy	$\pm(0.2\%$ of reading + 10mA) ($25 \pm 5^\circ\text{C}$)					
Setting resolution	0.1mA	1mA	1mA	0.1mA	0.1mA	
Display						
Voltage	5 digits display					
Current	5 digits display					
Voltage resolution	1mV	1mV	1mV	1mV	1mV	
Current resolution	0.1mA	1mA	1mA	0.1mA	0.1mA	
Readback accuracy ($25 \pm 5^\circ\text{C}$)	$\pm(0.02\%$ of reading + 5mV) $\pm(0.02\%$ of reading + 5mA)					
Protection						
	OLP, OVP, OCP, OTP and reverse polarity protection					
Key lock						
	Provided					
Interface						
	RS232 or USB interface, SCPI commands provided					
Save /Recall						
	100 sets					
Insulation						
	Between chassis and output terminal: $\geq 20\text{M}\Omega/500\text{VDC}$ Between chassis and AC cord: $\geq 30\text{M}\Omega/500\text{VDC}$					
Operation environment						
	Indoor use Altitude: $\leq 2000\text{m}$ Ambient temperature: $0 \sim 40^\circ\text{C}$ Relative humidity: $\leq 80\%$ Installation category: II Pollution degree: 2					
Storage environment						
	Ambient temperature: $-10 \sim 70^\circ\text{C}$ Relative humidity: $\leq 70\%$					
Power source						
	AC $110\text{V}/220\text{V} \pm 10\%$, 50/60Hz					
Accessories						
	Operation manual, Power cord, Software CD, RS232 cable or USB cable					
Dimension						
	296 (D) \times 126 (W) \times 143 (H)mm				396 (D) \times 126 (W) \times 143 (H)mm	
Weight						
	$\leq 7\text{kg}$	$\leq 6.4\text{kg}$	$\leq 7.5\text{kg}$	$\leq 6.3\text{kg}$	$\leq 8.8\text{kg}$	

6.2 Maximum Setting Value

Table 6.2-1

Model	Model A		Model B		Model C	Model D	Model E	Model F
Output range Item	36V/3A	15V/6A	36V/5A	15V/10A	30V/3A	30V/5A	60V/1A	60V/3A
Output voltage	36V	16V	36V	16V	32V	32V	62V	62V
Output current	3.2A	6.4A	5.1A	10.2A	3.2A	5.2A	1.2A	3.2A
OVP	38V		38V		0.1~34V	0.1~34V	0.1~64V	0.1~64V
OCP	6.5A		11A		0~3.5A	0~5.5A	0~1.5A	0~3.5A
Step voltage	36V	16V	36V	16V	32V	32V	62V	62V
Step current	3.2A	6.4A	5.1A	10.2A	3.2A	5.2A	1.2A	3.2A
Delay time	99999s							
Memory group	100							

Table 6.2-2

Model	Model G	Model H	Model I	Model J	Model K
Output range Item	60V/5A	20V/10A	30V/10A	75V/3A	75V/5A
Output voltage	62V	22V	32V	75V	75V
Output current	5.2A	10.2A	10.2A	3.2A	5.2A
OVP	64V	24V	34V	80V	80V
OCP	5.5A	11A	11A	3.5A	5.5A
Step voltage	62V	22V	32V	75V	75V
Step current	5.2A	10.2A	10.2A	3.2A	5.2A
Delay time	99999s				
Memory group	100				